

# Schlauchwagen Katastrophenschutz

## Mercedes Benz Atego

Erstellt für das

Bundesamt für Bevölkerungsschutz und Katastrophenhilfe (BBK)

Provinzialstraße 93, 53127 Bonn

[www.bbk.bund.de](http://www.bbk.bund.de)

Vervielfältigungen oder Änderungen sind nur mit der Zustimmung des BBK gestattet.

Design: Volker Preikschat

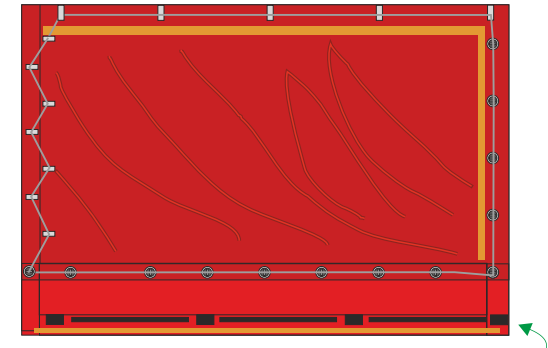
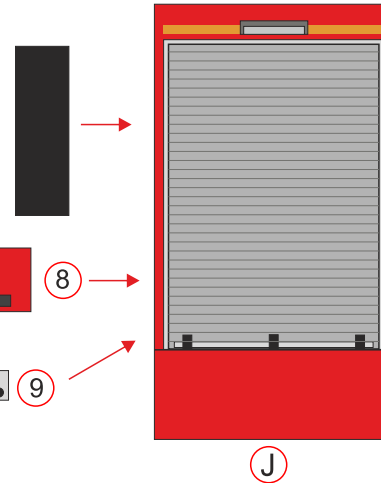
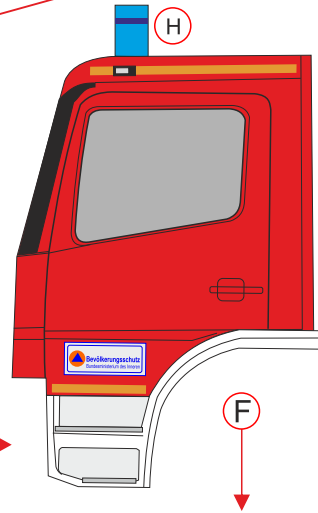
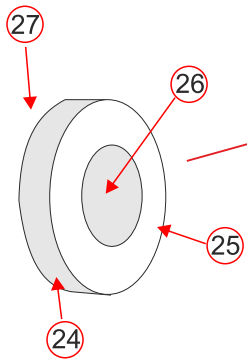
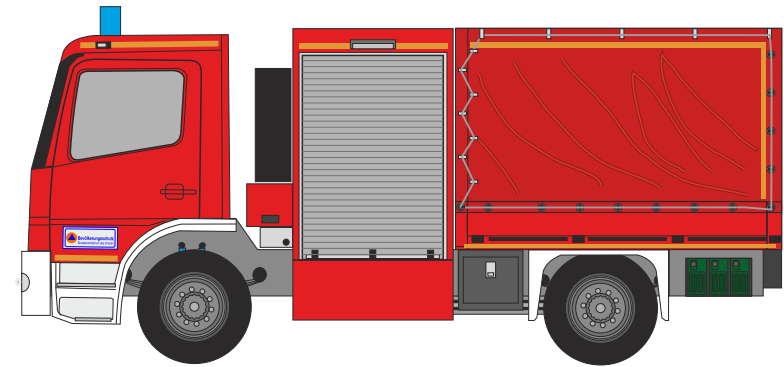

SW - KatS  
(C) 04/2014 Bundesamt für  
Bevölkerungsschutz  
und Katastrophenhilfe  
Design: V.Preikschat

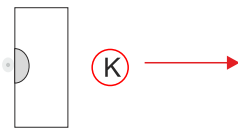

1/4

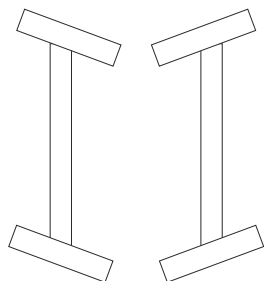

3

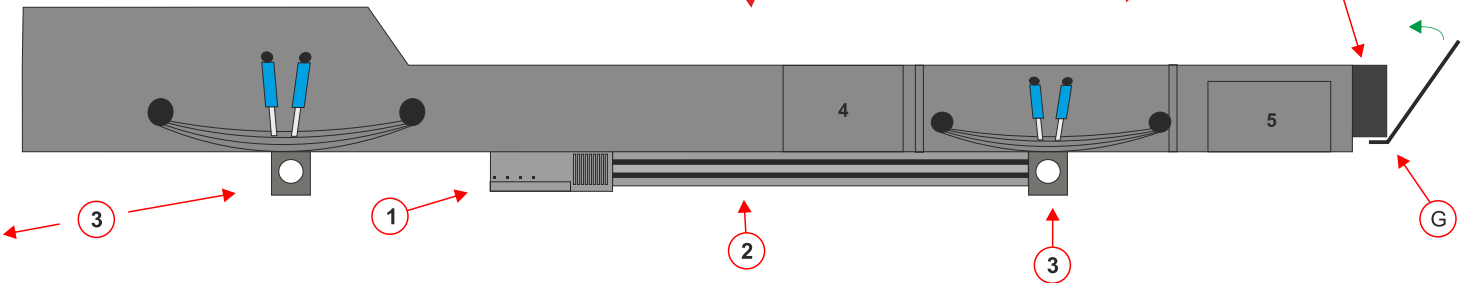

1

2

3

4

5

C

G

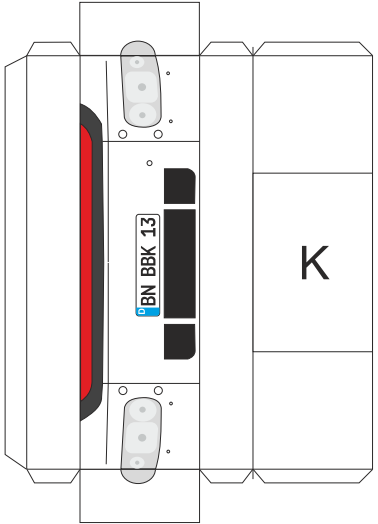
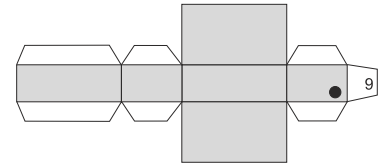
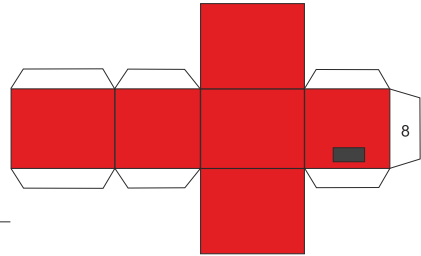
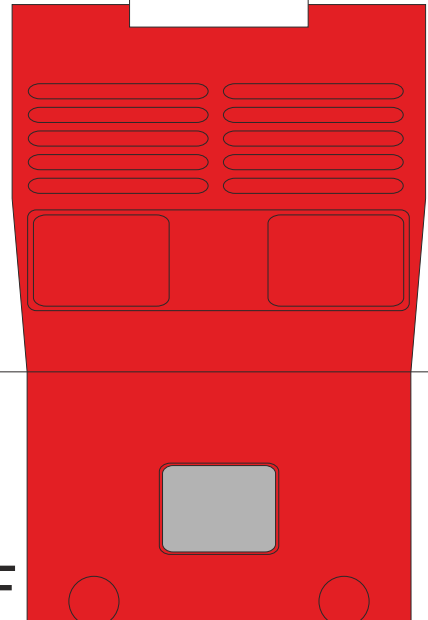
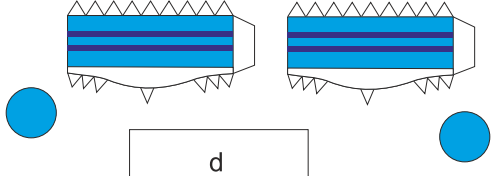

F

J

2/4

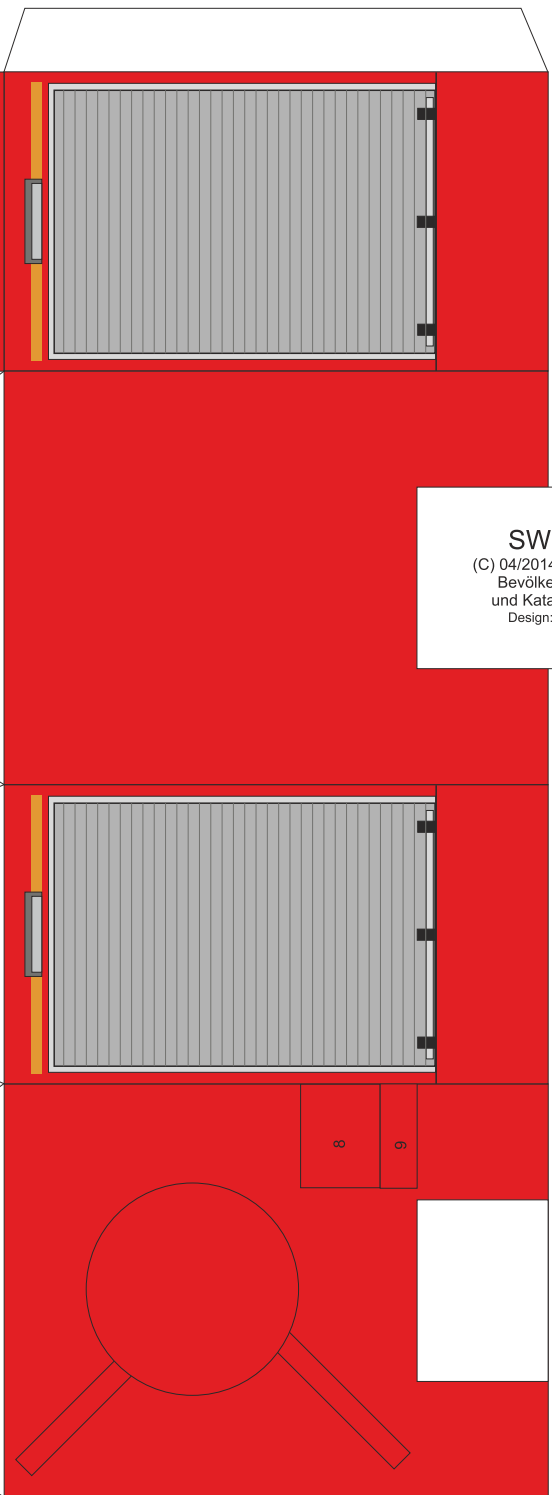
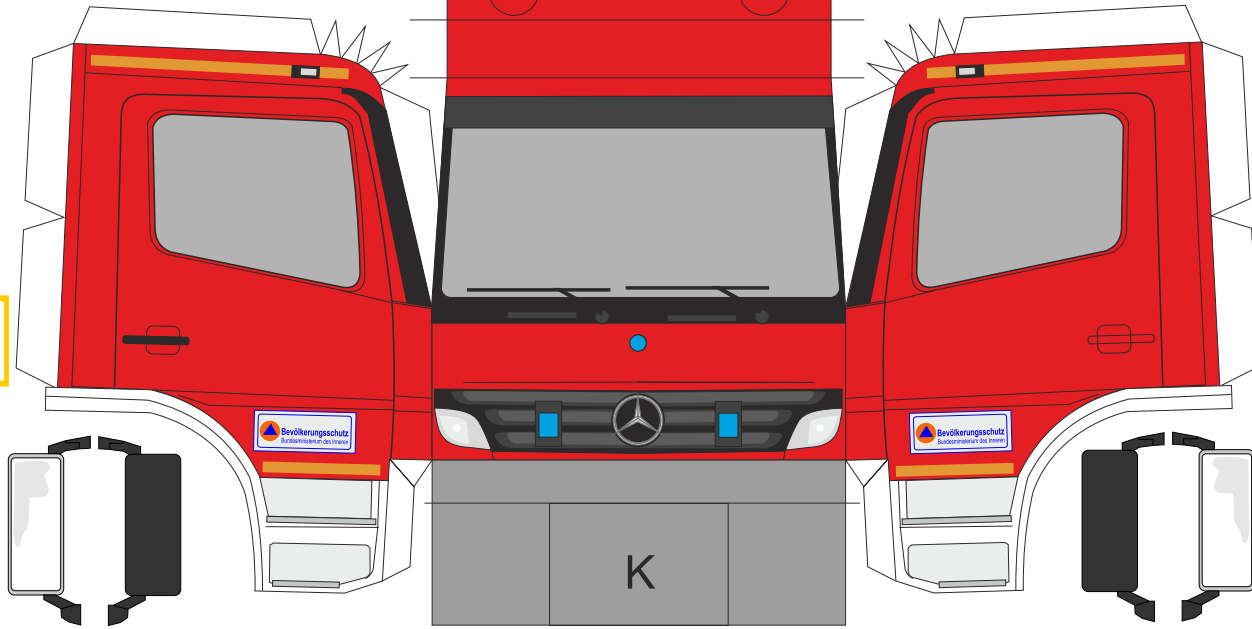

SW - KatS  
(C) 04/2014 Bundesamt für  
Bevölkerungsschutz  
und Katastrophenhilfe  
Design: V.Preikschat

8  
9

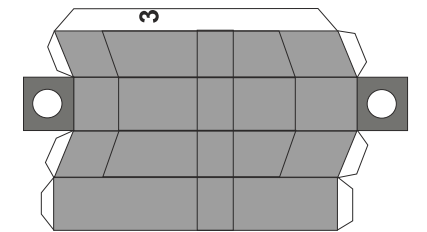
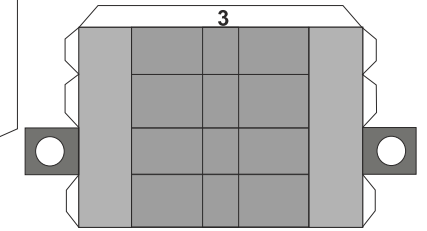
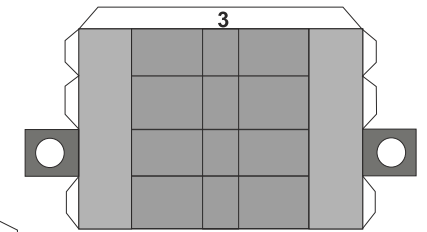
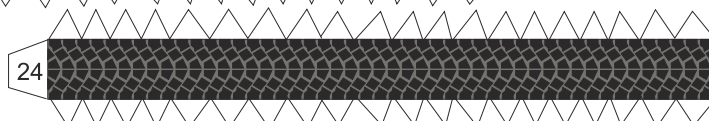
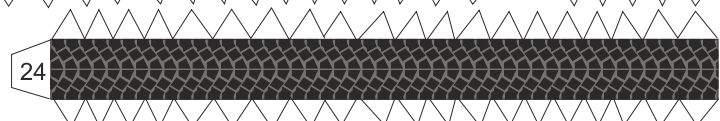
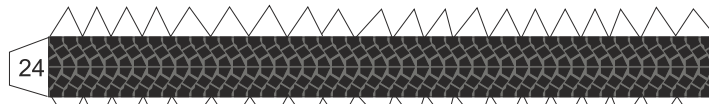
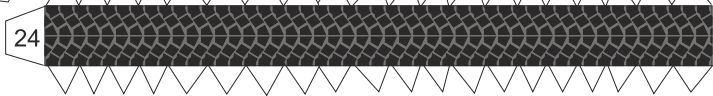
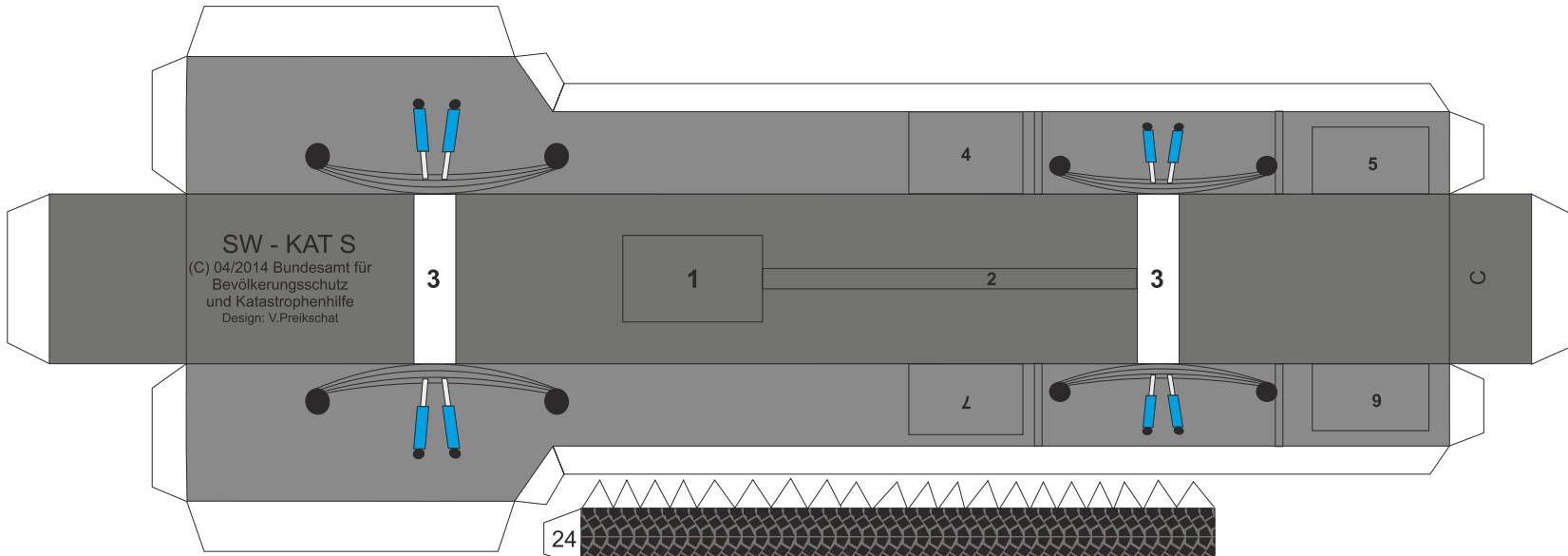

3/4

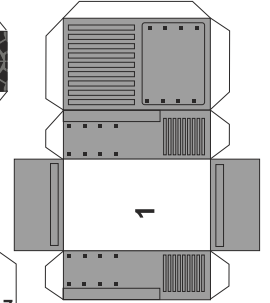
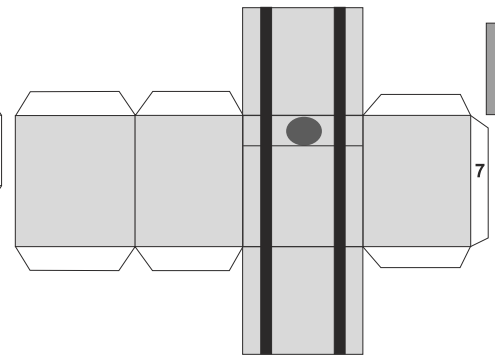
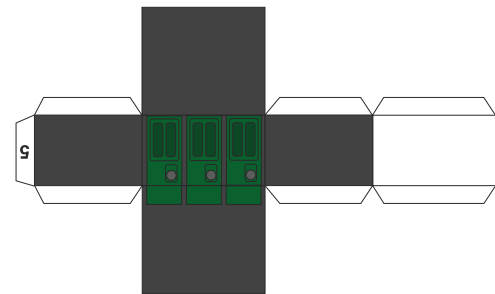
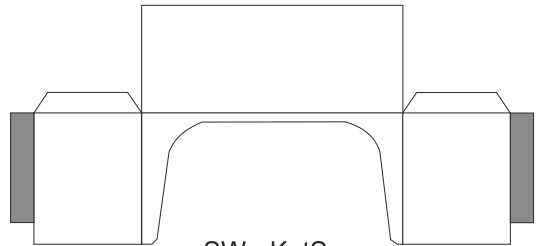
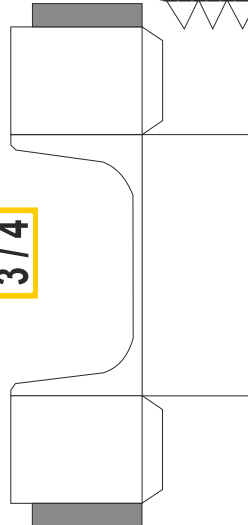

SW - KatS  
 (C) 04/2014 Bundesamt für  
 Bevölkerungsschutz  
 und Katastrophenhilfe  
 Design: V.Preikschat

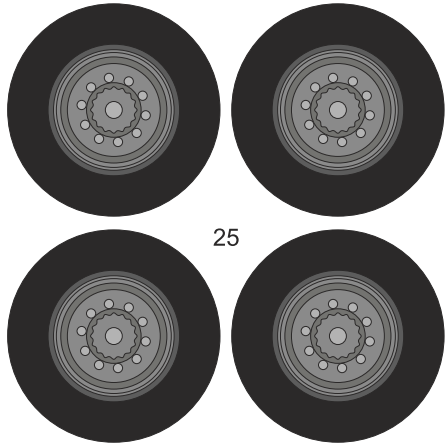

25

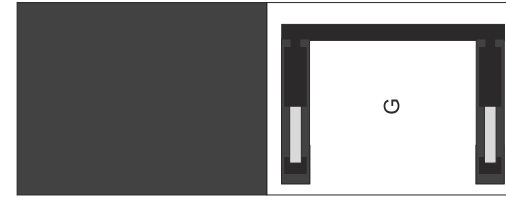
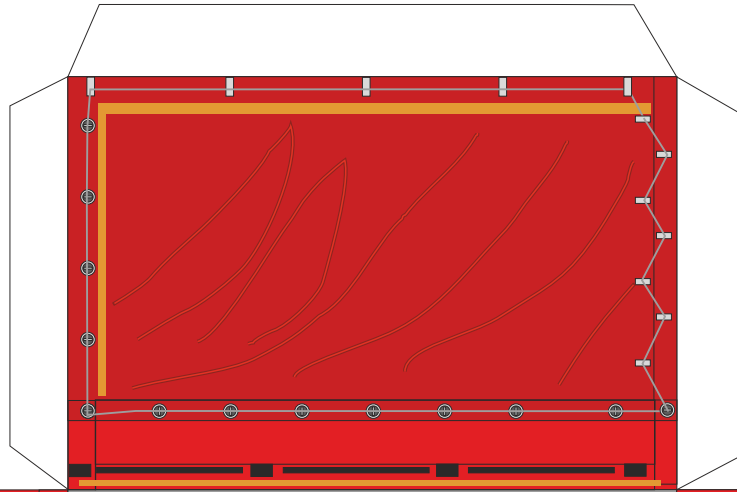

G

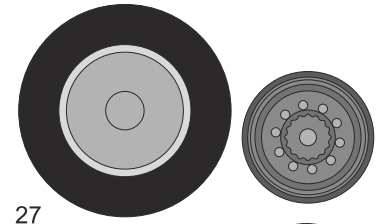

27

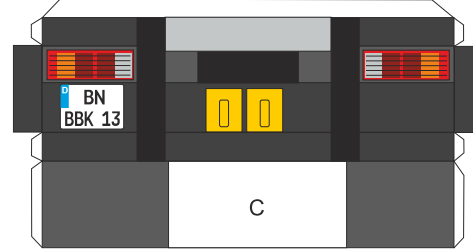

C

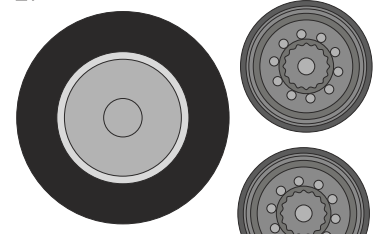

25

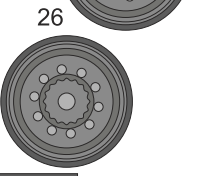

26

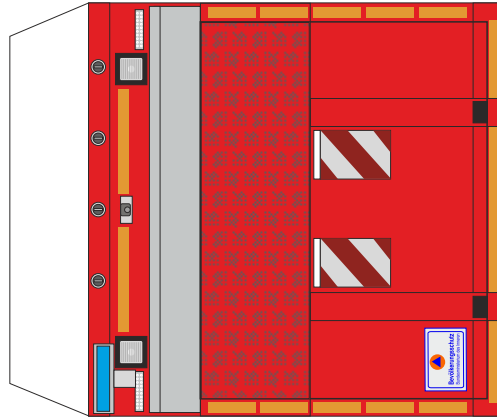

SW KatS  
(C) 04/2014 Bundesamt für  
Bevölkerungsschutz  
und Katastrophenhilfe  
Design: V.Preischat



E

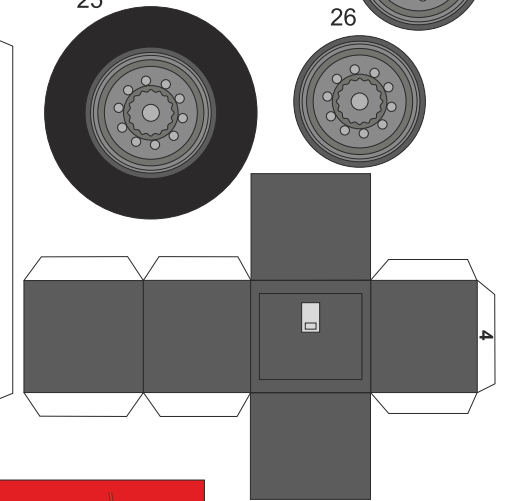

4

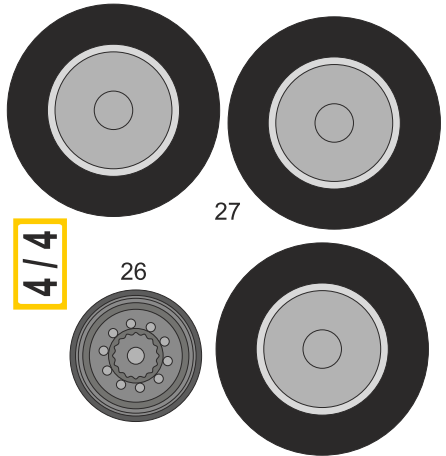

27

4/4

26

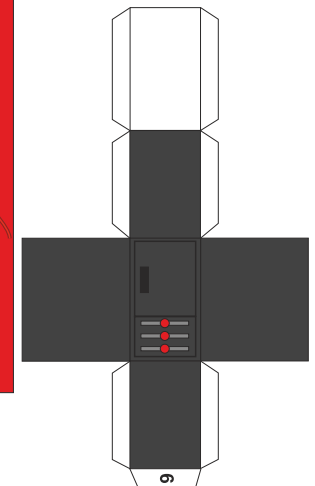
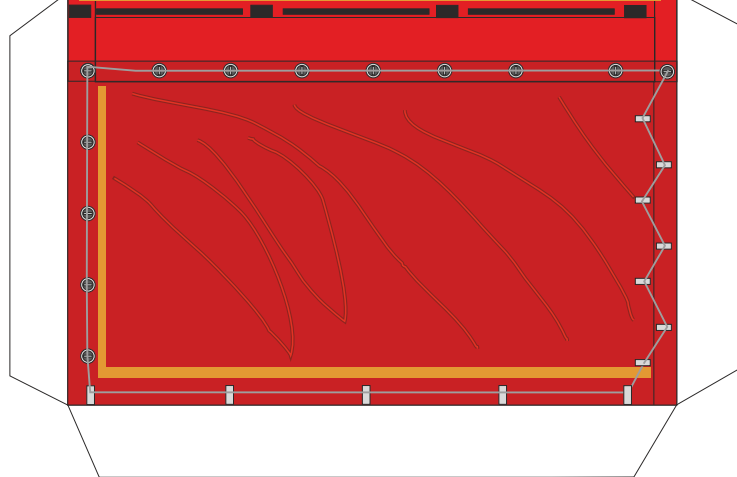

6